

Polaris Threshold V3

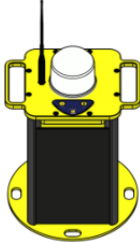
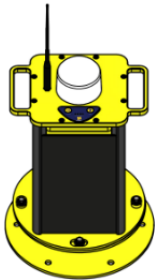
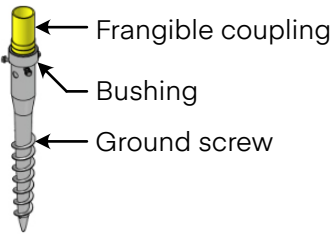

<p>Compliance to Standards</p>	<p>ICAO: International Civil Aviation Organization, Airports, Annex 14, Vol. 1</p> <p>IEC TS 61827: Electrical installations for the lighting and signaling of aerodromes. Characteristics of recessed and raised luminaires used at aerodromes and heliports.</p> <p>TP 312E: Aerodromes Standards and Recommended Practices</p> <p>FAA: AC 150/5345-46F</p> <p>Part 139 (Aerodromes) Manual of Standards</p>
<p>Application</p>	<p>Battery-powered directional green lights for airport runways, indicating the runway threshold and providing visual guidance to pilots, with low and medium intensity output in compliance with ICAO standards.</p> <p>The POLARIS design has been done in such way as to provide maximum safety.</p> <p>It is a reliable and flexible product, being easy to fit into any kind of infrastructure.</p>
<p>Features</p>	<p>Designed and built with simplicity and ease of maintenance in mind. High power LED technology (100 000 hrs lifespan). Lightweight, low-energy and environment friendly lighting fitting. Lead Acid battery Steady with brightness control 1%, 3%, 10%, 30% and 100% Local/manual control Battery status LEDs</p> <p>Optional:</p> <p>Infrared - invisible light to the naked eye, NVG compatible. Photocell sensor - automatically switches between day and night operating modes. Radio control - one or two way GPS incorporated ARCAL - pilot activation</p>

<p>Product Code</p>	<p>AL - 189 - 03 - GR</p> <p>Series Indicator (Airfield Lighting) AL Product Indicator 189 LEDs Number 03 LEDs Light Color (Green) GR</p> <p>Optional:</p> <p>IR LED IR</p> <p><i>When the infrared (IR) option is included, the IR LEDs are added to the number of visible LEDs indicated in the code. Depending on the configuration, one or two IR LEDs may be included.</i></p> <table border="1" data-bbox="523 743 1401 873"> <thead> <tr> <th colspan="2">Examples of codes:</th> </tr> </thead> <tbody> <tr> <td>IR not included</td> <td>AL-189-03-GR</td> </tr> <tr> <td>IR included (one IR led)</td> <td>AL-189-04-GR/IR</td> </tr> <tr> <td>IR included (two IR leds)</td> <td>AL-189-05-GR/IR</td> </tr> </tbody> </table>	Examples of codes:		IR not included	AL-189-03-GR	IR included (one IR led)	AL-189- 04 -GR/IR	IR included (two IR leds)	AL-189- 05 -GR/IR
Examples of codes:									
IR not included	AL-189-03-GR								
IR included (one IR led)	AL-189- 04 -GR/IR								
IR included (two IR leds)	AL-189- 05 -GR/IR								
<p>Description</p>	<p>Housing - powder coated aluminum RAL 1004 (aviation yellow) </p> <p>Dispenser - hardened glass</p> <p>Cable gland - nickel plated brass</p> <p>Fasteners - stainless steel</p> <p>Light fixtures are provided with anti-condensation valve.</p>								
<p>Environment</p>	<p>Temperature range: -20°C to +55°C</p> <p>Degree of protection: IP67</p> <p>Humidity: 0-100%</p>								
<p>Mounting</p>	<div style="display: flex; justify-content: space-around;"> <div data-bbox="635 1444 774 1684">  <p>Installed directly on the ground (no fasteners required)</p> </div> <div data-bbox="1177 1406 1332 1684">  <p>On a base plate and a frangible coupling</p> </div> </div> <p>When installed directly on grass, sand, or soil without a solid foundation, the lamp can be mounted on a ground screw with an integrated bushing and frangible coupling.</p> <div data-bbox="1098 1809 1433 2042">  <p>Frangible coupling Bushing Ground screw</p> </div>								

Electrical Characteristics

Power consumption: maximum 4 W powered at 100% brightness

Power supply: rechargeable 12 V - 12 Ah Lead Acid battery or **optional** 12 V - 12 Ah Lithium Iron Phosphate (LiFePO₄) battery.

Solar panels: 4x5 W

Autonomy under ideal conditions

(new battery, fully charged at 100%, external temperature of 20° Celsius)

Brightness level: 100% - 36 h
 30% - 120 h
 10% - 360 h
 3% - 1200 h
 1% - 3600 h

Charging

The primary charging method for Polaris V3 lamps is via the four integrated solar panels. Additionally, the lamps are equipped with a DC connector for optional external charging.

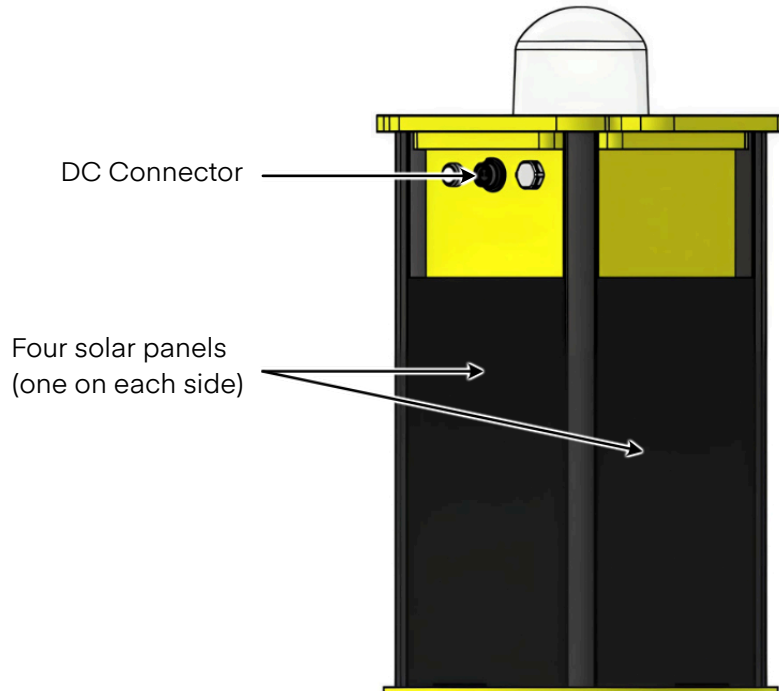

Local/manual Control

The lamps can be controlled locally using the buttons on the control panel of each lamp.

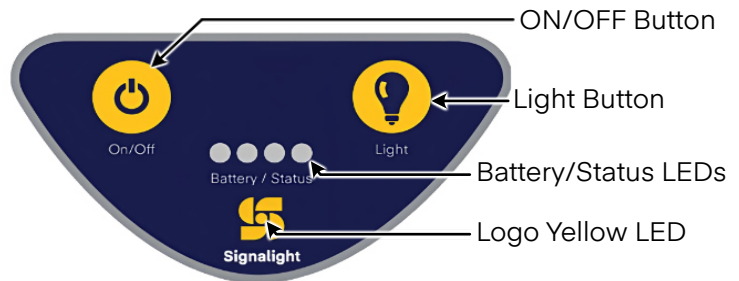

After installation, press the **ON/OFF button** to connect the internal battery and power on the unit. Once powered, the yellow LED in the SIGNALIGHT logo will blink every 5 seconds, indicating that the unit is in **Standby mode**. After pressing the button, the first LED of the battery/status will light up:



At this moment, the lamp requests access to the system. After a few seconds, the lamp receives access to the system, at which point the third LED will light up:



Press the **Light button** once to display the current battery charge level using the 4 blue LEDs.

Battery Charged 75-100%	Battery Charged 50-75%	Battery Charged 25-50%	Battery Charged 0-25%

The diagram shows four battery charge levels, each with a corresponding control panel. The 'Battery / Status' LEDs are lit in blue to indicate the charge level: 4 LEDs for 75-100%, 3 LEDs for 50-75%, 2 LEDs for 25-50%, and 1 LED for 0-25%.

Local/manual Control

Switching between modes can only be performed while the blue LEDs indicating the battery level are lit. These LEDs automatically turn off after approximately 8 seconds. Therefore, if the **Light button** is pressed after a longer period of inactivity, the first press will only activate the battery level indicators, and the lamp will switch to the next mode on the second press of the **Light button**.

Subsequent presses of the **Light** button will cycle through increasing light intensities as follows:

- 2nd press → 1% brightness
- 3rd press → 3% brightness
- 4th press → 10% brightness
- 5th press → 30% brightness
- 6th press → 100% brightness

Photocell Mode (Optional)

Pressing the **Light button** a seventh time will activate **photocell mode** (if included), where the light operates automatically based on ambient light conditions.

When the lamp enters photocell mode, the main LED will flash six times, and the yellow LED in the SIGNALIGHT logo will blink three times, with the third flash being slightly longer than the first two. This sequence repeats every 5 seconds for as long as the lamp remains in photocell mode.

Pressing the **Light button** once more will turn off the light and return the unit to Standby mode.

In Standby, the yellow SIGNALIGHT logo LED will continue blinking once every 5 seconds.

When the lamp switches from photocell mode (if included) to standby mode, the main LED will flash rapidly four times.

Low battery

If the battery voltage drops down below 10,5 V, the MAIN LEDs are automatically turning OFF.

To protect the battery from over-discharging and potential damage, if the battery voltage drops below 10.2 volts, it will automatically disconnect.

Disconnecting the battery

Holding down the **Light button** for more than 3 seconds will disconnect the battery. This step is advised when the lamps will not be used for an extended period or during transportation to ensure there is no power consumption. Prior to disconnection, the main LEDs will blink three times as an indicator. Once the battery is disconnected, the LED on the logo will turn off.



Look/See

ON/OFF Button: Connects the battery and the light enters standby mode

Light Button:

- 1st press → Battery status
- 2nd press → 1% light intensity
- 3rd press → 3% light intensity
- 4th press → 10% light intensity
- 5th press → 30% light intensity
- 6th press → 100% light intensity
- 7th press → Photocell mode (if included)
- 8th press → Standby mode

Note:

If the photocell is not equipped, the unit enters Standby mode on the 7th press.

Radio Control

Optional the Polaris lights can be radio controlled.

Radio control is made using LORA technology in 868 Mhz for Europe or 915 Mhz for US, optional 433 Mhz.

The lights can be controlled one way using a handled remote control.

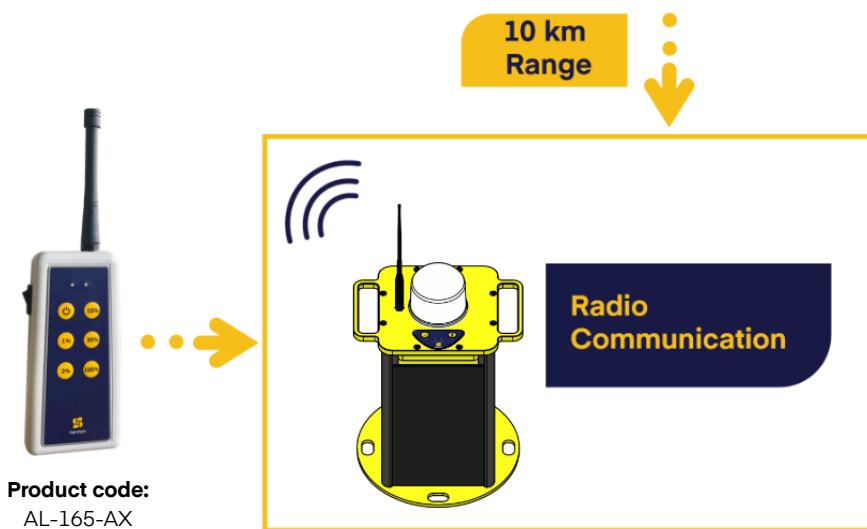

One way communications means all the lights can be started at 1%, 3%, 10%, 30% or 100% or switched OFF.

Optionally, the lamps can be controlled in groups, pre-set at the factory through a customized remote control

Polaris Application

Another option is to control the lights using a base station, in this case the communication is bidirectional via Polaris application.

The distance covered can be up to 10 km in line of sight.

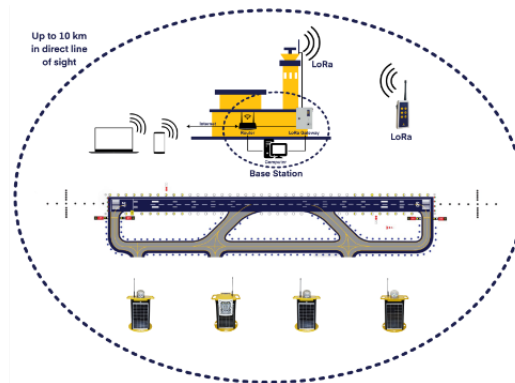

From the POLARIS application the control is more complex. The lights can be controlled individual, in groups, on scenarios and the user can see all the parameters of the lights.

ARCAL – Pilot activation

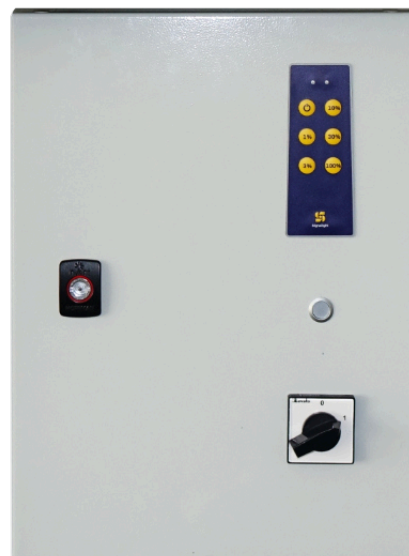

This option allows pilots to activate the lights using the communication system. **Three clicks** on the microphone set the lamps to **10%** intensity, **five clicks** to **30%**, and **seven clicks** to **100%**.

Mechanical Characteristics

Weight: 9.3 kg

Dimensions without base plate and frangible coupling

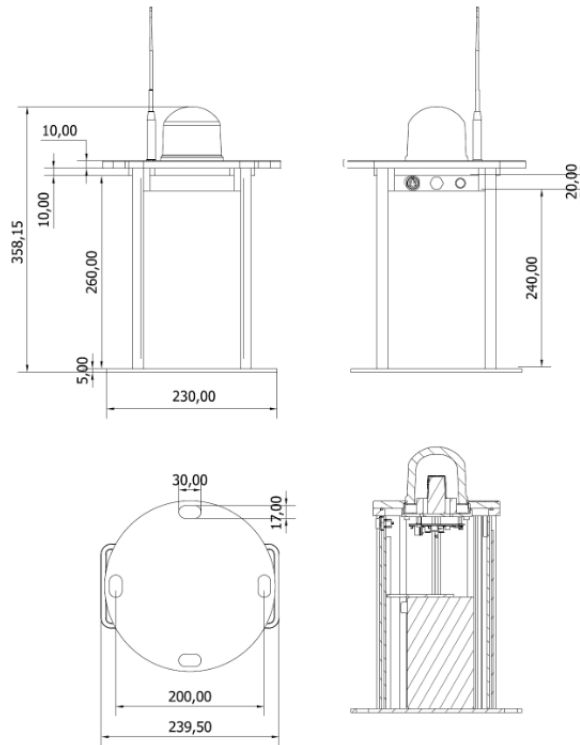

Dimensions with base plate and frangible coupling

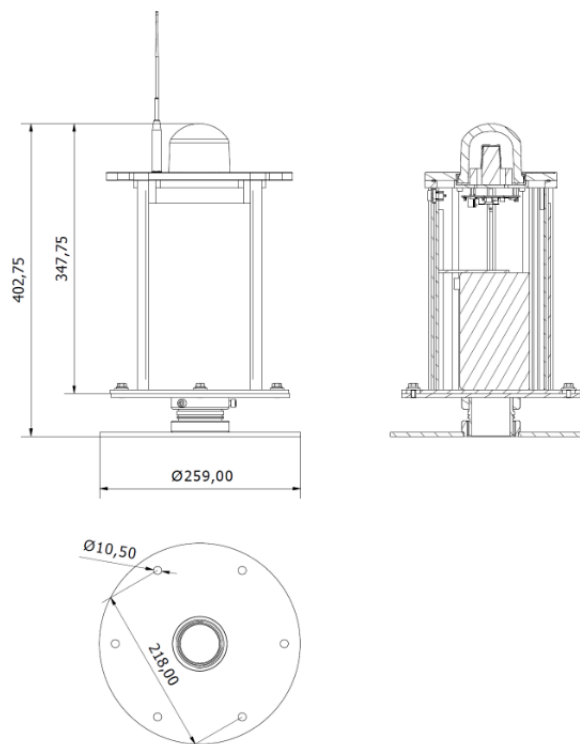

Photometric Characteristics

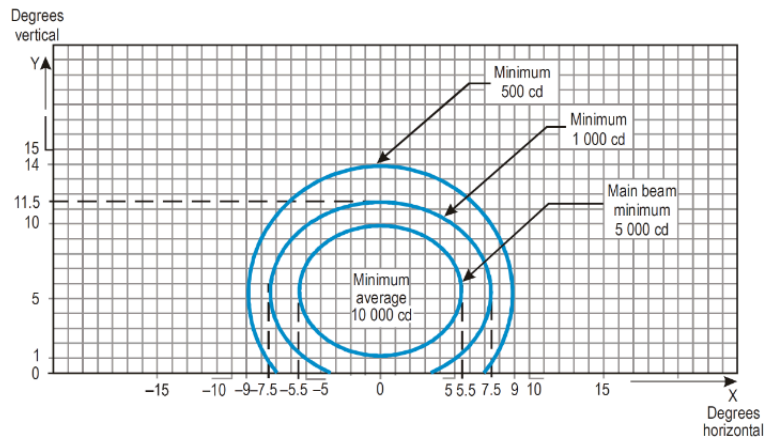

ICAO requirements Annex 14 Vol.1 Fig. A2-3.

Low intensity: 10% Average 1000 cd

Medium intensity: 30% Average 3000 cd

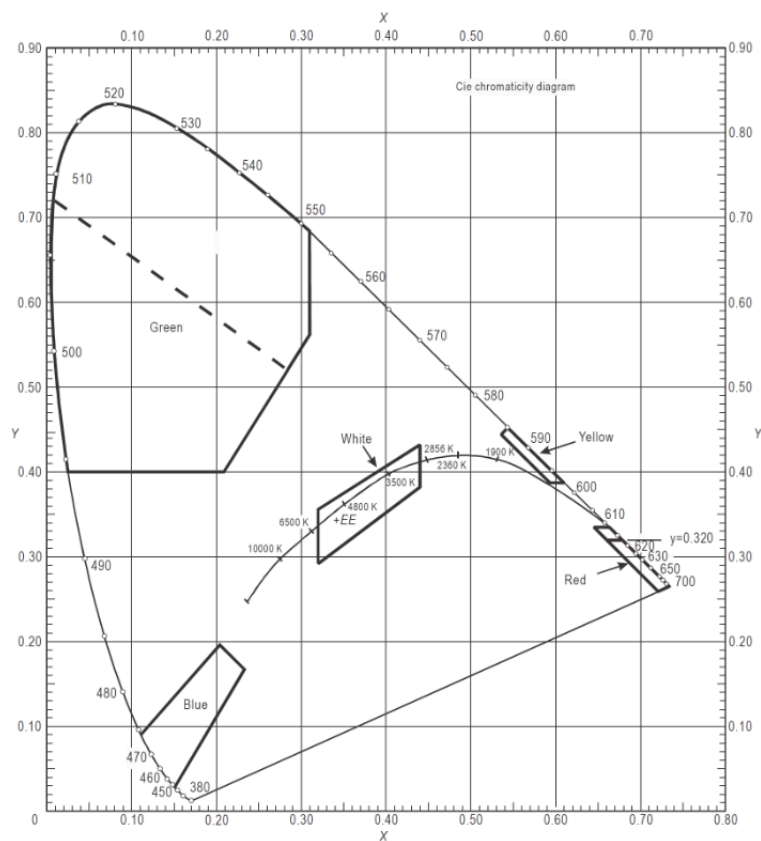

The measured trichromatic coordinates correspond to color range requirements in:

ICAO Annex 14 - Aerodromes Vol.1, fig, A1-1b.

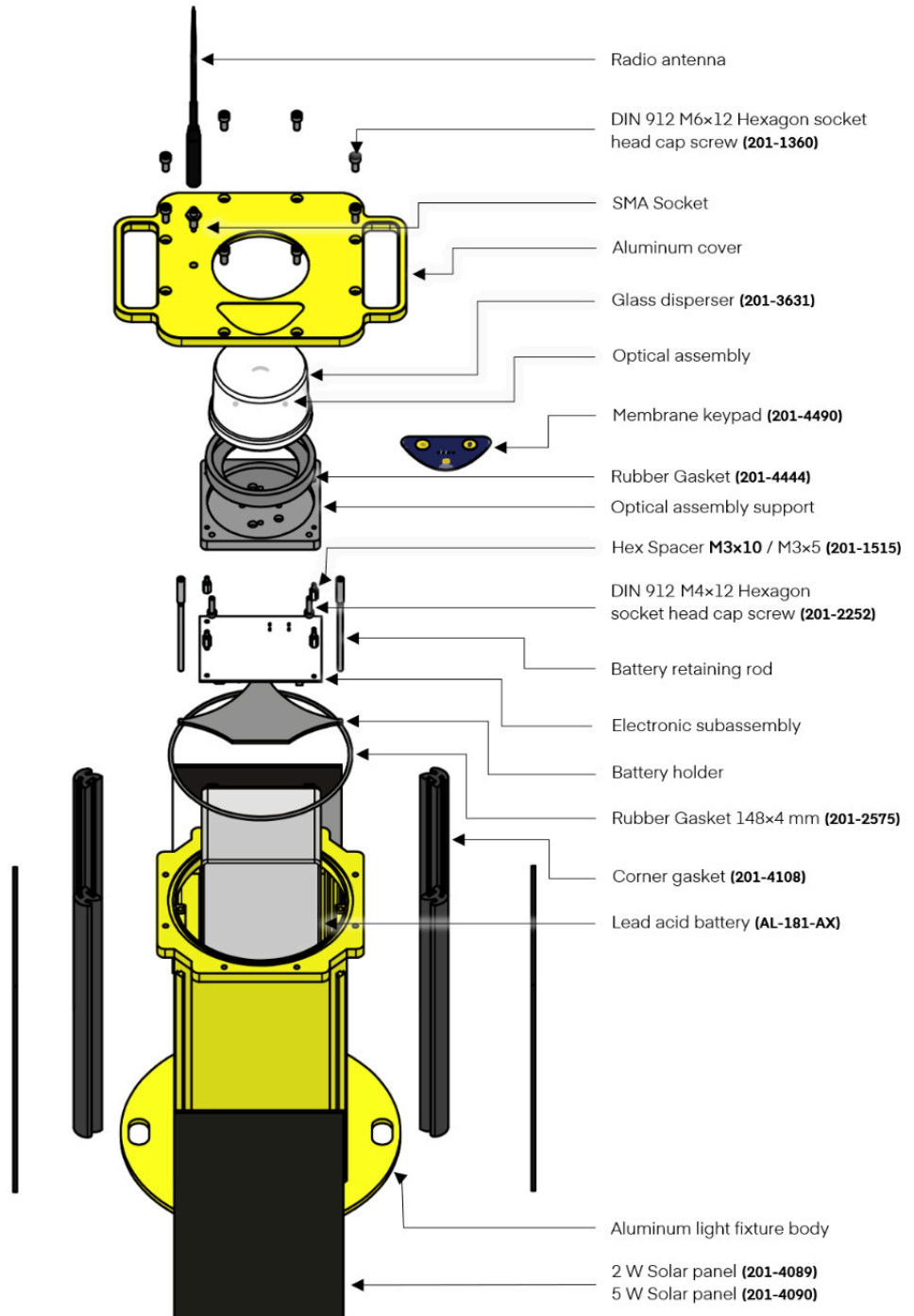

Colors for aeronautical ground lights (solid state lighting)

Spare Parts

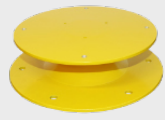

Accessory

To order accessories please call our customer support. For contact details please refer to our website - www.signalight.com

#	NAME - SERIES	PRODUCT CODE	IMAGE
1	Fixing System for Polaris V3	AL-232-AX	
2	Ground mounting screw	AL-229-AX	



Signalight

+40 254 515 465
office@signalight.com

36 Lunca Street, Petrosani,
Hunedoara County, Romania

www.signalight.com