



Polaris Taxiway V3



<p>Compliance to Standards</p>	<p>ICAO: International Civil Aviation Organization, Airports, Annex 14, Vol. 1</p> <p>IEC TS 61827: Electrical installations for the lighting and signaling of aerodromes. Characteristics of recessed and raised luminaires used at aerodromes and heliports.</p> <p>TP 312E: Aerodromes Standards and Recommended Practices</p> <p>FAA: AC 150/5345-46F</p> <p>Part 139 (Aerodromes) Manual of Standards</p>
<p>Application</p>	<p>Battery-powered omnidirectional blue lights for airports and aerodromes, used to guide pilots during ground operations, in compliance with ICAO standards.</p> <p>The POLARIS design has been done in such way as to provide maximum safety.</p> <p>It is a reliable and flexible product, being easy to fit into any kind of infrastructure.</p>
<p>Features</p>	<p>Designed and built with simplicity and ease of maintenance in mind. High power LED technology (100 000 hrs lifespan). Lightweight, low-energy and environment friendly lighting fitting. Lead Acid battery Steady brightness 2 cd omnidirectional Local/manual control Battery status LEDs</p> <p>Optional:</p> <p>Infrared - invisible light to the naked eye, NVG compatible. Photocell sensor - automatically switches between day and night operating modes. Radio control - one or two way GPS incorporated ARCAL - pilot activation</p>

<p>Product Code</p>	<p>AL - 192 - 01 - BL</p> <p>Series Indicator (Airfield Lighting) AL Product Indicator 192 LEDs Number 01 LEDs Light Color (Blue) BL</p> <p>Optional:</p> <p>IR LED IR</p> <p><i>When the infrared (IR) option is included, the IR LEDs are added to the number of visible LEDs indicated in the code. Depending on the configuration, one or two IR LEDs may be included.</i></p> <table border="1" data-bbox="523 757 1401 887"> <thead> <tr> <th colspan="2">Examples of codes:</th> </tr> </thead> <tbody> <tr> <td>IR not included</td> <td>AL-192-01-BL</td> </tr> <tr> <td>IR included (one IR led)</td> <td>AL-192-02-BL/IR</td> </tr> <tr> <td>IR included (two IR leds)</td> <td>AL-192-03-BL/IR</td> </tr> </tbody> </table>	Examples of codes:		IR not included	AL-192-01-BL	IR included (one IR led)	AL-192- 02 -BL/IR	IR included (two IR leds)	AL-192- 03 -BL/IR
Examples of codes:									
IR not included	AL-192-01-BL								
IR included (one IR led)	AL-192- 02 -BL/IR								
IR included (two IR leds)	AL-192- 03 -BL/IR								
<p>Description</p>	<p>Housing - powder coated aluminum RAL 1004 (aviation yellow) </p> <p>Dispenser - hardened glass</p> <p>Cable gland - nickel plated brass</p> <p>Fasteners - stainless steel</p> <p>Light fixtures are provided with anti-condensation valve.</p>								
<p>Environment</p>	<p>Temperature range: -20°C to +55°C</p> <p>Degree of protection: IP67</p> <p>Humidity: 0-100%</p>								
<p>Mounting</p>	<div style="display: flex; justify-content: space-around;"> <div data-bbox="635 1442 775 1684">  <p>Installed directly on the ground (no fasteners required)</p> </div> <div data-bbox="1177 1406 1331 1684">  <p>On a base plate and a frangible coupling</p> </div> </div> <p>When installed directly on grass, sand, or soil without a solid foundation, the lamp can be mounted on a ground screw with an integrated bushing and frangible coupling.</p> <div data-bbox="1098 1809 1433 2042">  <p>Frangible coupling Bushing Ground screw</p> </div>								

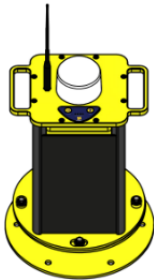
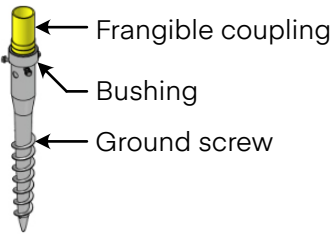
Electrical Characteristics

Lamp version	Power consumption	Power supply	Solar panels	Autonomy
Standard	0,2 W	Lead Acid or LiFePO ₄ (optional) Battery 12 V - 12 Ah	4x5 W	aprox. 720 hours
Compact	0,2 W	LiFePO ₄ Battery 3.6 V - 12 Ah	4x2 W	aprox. 216 hours

Autonomy measured under ideal conditions: with a new, fully charged battery and an ambient temperature of 20°C.

Charging

The primary charging method for Polaris V3 lamps is via the four integrated solar panels. Additionally, the lamps are equipped with a DC connector for optional external charging.

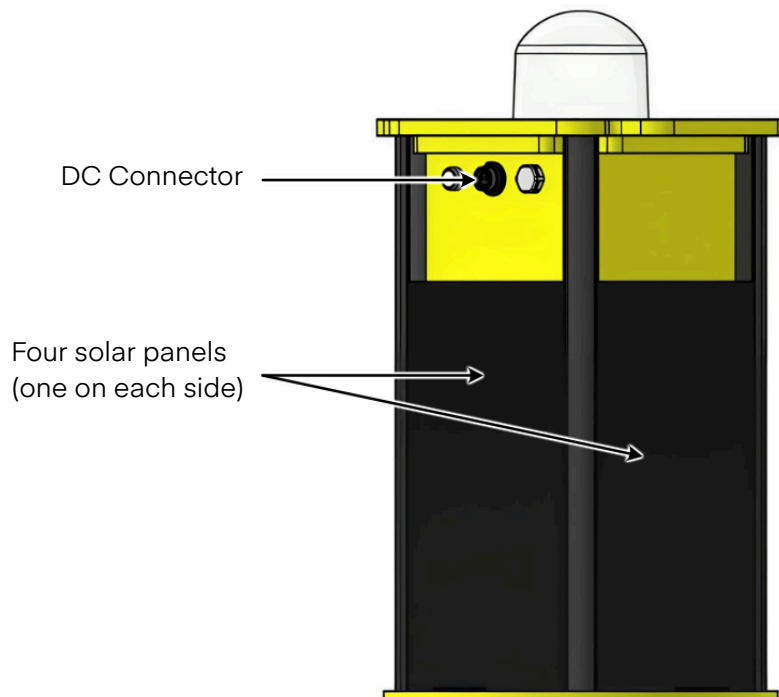

Local/manual Control

The lamps can be controlled locally using the buttons on the control panel of each lamp.

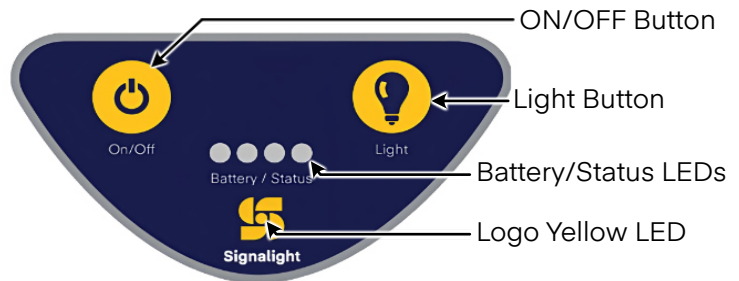

After installation, press the **ON/OFF button** to connect the internal battery and power on the unit. Once powered, the yellow LED in the SIGNALIGHT logo will blink every 5 seconds, indicating that the unit is in **Standby mode**. After pressing the button, the first LED of the battery/status will light up:



At this moment, the lamp requests access to the system. After a few seconds, the lamp receives access to the system, at which point the third LED will light up:



Press the **Light button** once to display the current battery charge level using the 4 blue LEDs.

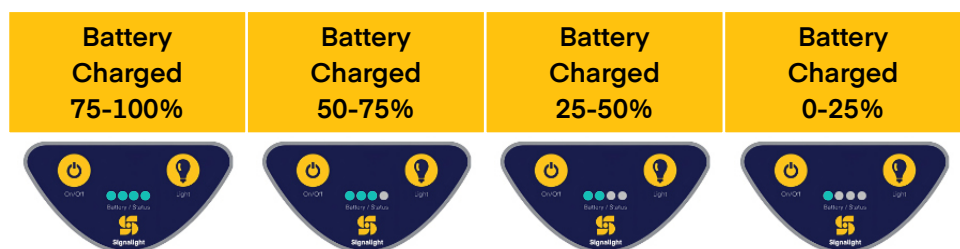

Local/manual Control

Switching between modes can only be performed while the blue LEDs indicating the battery level are lit. These LEDs automatically turn off after approximately 8 seconds. Therefore, if the **Light button** is pressed after a longer period of inactivity, the first press will only activate the battery level indicators, and the lamp will switch to the next mode on the second press of the **Light button**.

Subsequent presses of the **Light** button will cycle through increasing light intensities as follows:

- 2nd press → 1% brightness
- 3rd press → 3% brightness
- 4th press → 10% brightness
- 5th press → 30% brightness
- 6th press → 100% brightness

Photocell Mode (Optional)

Pressing the **Light button** a seventh time will activate **photocell mode** (if included), where the light operates automatically based on ambient light conditions.

When the lamp enters photocell mode, the main LED will flash six times, and the yellow LED in the SIGNALIGHT logo will blink three times, with the third flash being slightly longer than the first two. This sequence repeats every 5 seconds for as long as the lamp remains in photocell mode.

Pressing the **Light button** once more will turn off the light and return the unit to Standby mode.

In Standby, the yellow SIGNALIGHT logo LED will continue blinking once every 5 seconds.

When the lamp switches from photocell mode (if included) to standby mode, the main LED will flash rapidly four times.

Low battery

If the battery voltage drops down below 10,5 V, the MAIN LEDs are automatically turning OFF.

To protect the battery from over-discharging and potential damage, if the battery voltage drops below 10.2 volts, it will automatically disconnect.

Disconnecting the battery

Holding down the **Light button** for more than 3 seconds will disconnect the battery. This step is advised when the lamps will not be used for an extended period or during transportation to ensure there is no power consumption. Prior to disconnection, the main LEDs will blink three times as an indicator. Once the battery is disconnected, the LED on the logo will turn off.

Radio Control



ON/OFF Button: Connects the battery and the light enters standby mode
Light Button:

- 1st press → Battery status
- 2nd press → 1% light intensity
- 3rd press → 3% light intensity
- 4th press → 10% light intensity
- 5th press → 30% light intensity
- 6th press → 100% light intensity
- 7th press → Photocell mode (if included)
- 8th press → Standby mode

Note: The taxiway lamp allows selection of all five adjustable light intensity levels via the control panel, depending on operational requirements; however, only the 100% intensity level is ICAO compliant.

Note: If the photocell is not equipped, the unit enters Standby mode on the 7th press.

Optional the Polaris lights can be radio controlled.

Radio control is made using LORA technology in 868 Mhz for Europe or 915 Mhz for US, optional 433 Mhz.

The lights can be controlled one way using a handled remote control.

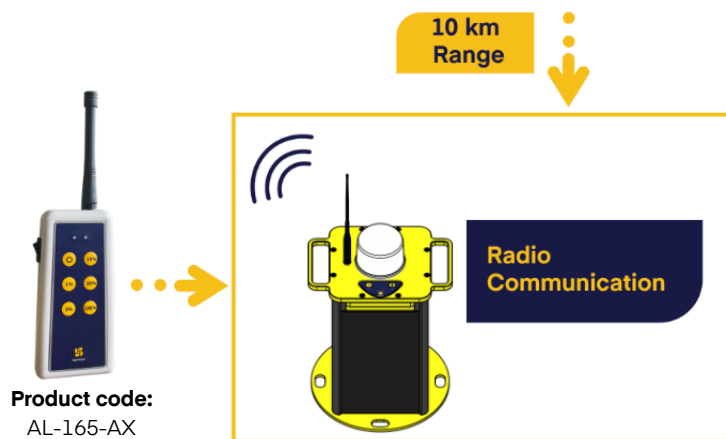

One way communications means all the lights can be started at 1%, 3%, 10%, 30% or 100% or switched OFF.

Optionally, the lamps can be controlled in groups, pre-set at the factory through a customized remote control



Note: The taxiway lamp allows selection of all five adjustable light intensity levels via the remote control, depending on operational requirements; however, only the 100% intensity level is ICAO compliant.

Polaris Application

Another option is to control the lights using a base station, in this case the communication is bidirectional via Polaris application.

The distance covered can be up to 10 km in line of sight.

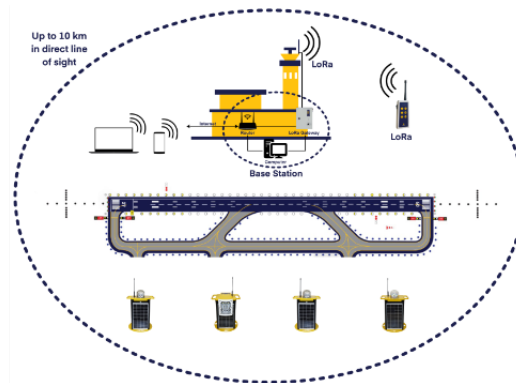

From the POLARIS application the control is more complex. The lights can be controlled individual, in groups, on scenarios and the user can see all the parameters of the lights.

ARCAL – Pilot activation

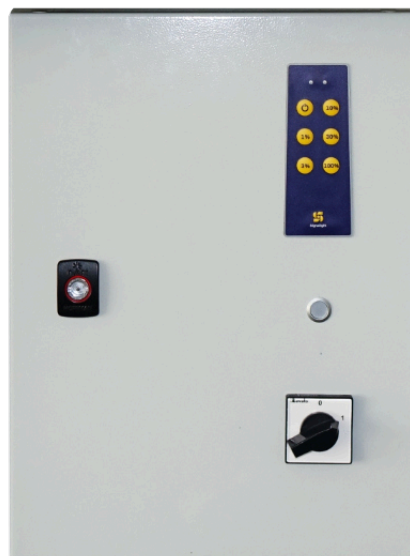

This option allows pilots to activate the lights using the communication system. **Three clicks** on the microphone set the lamps to **10%** intensity, **five clicks** to **30%**, and **seven clicks** to **100%**.

Mechanical Characteristics

Weight: 9.3 kg

Dimensions of the standard version:

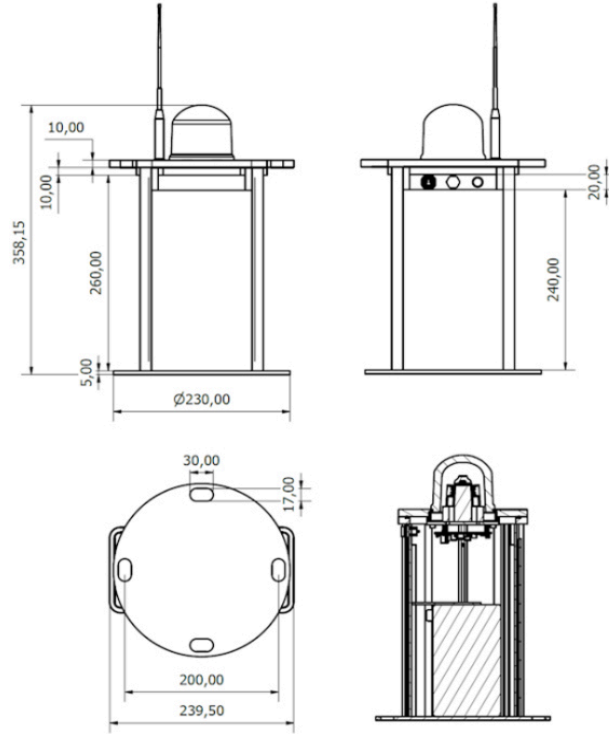

Weight: 4 kg

Dimensions of the compact version:

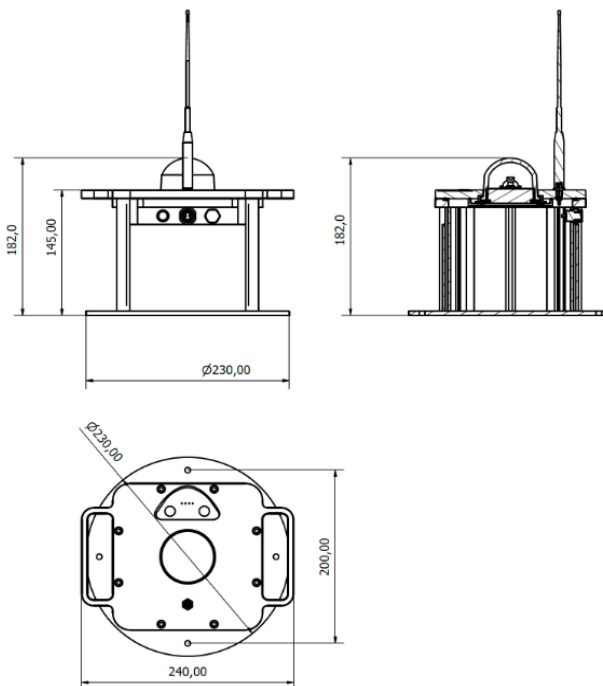

Photometric Characteristics

The intensity of taxiway edge lights shall be at least 2 cd from 0° to 6° vertical, and 0.2 cd at any vertical angles between 6° and 75°.

ICAO requirements Annex 14 Vol.1 - 5.3.18.8

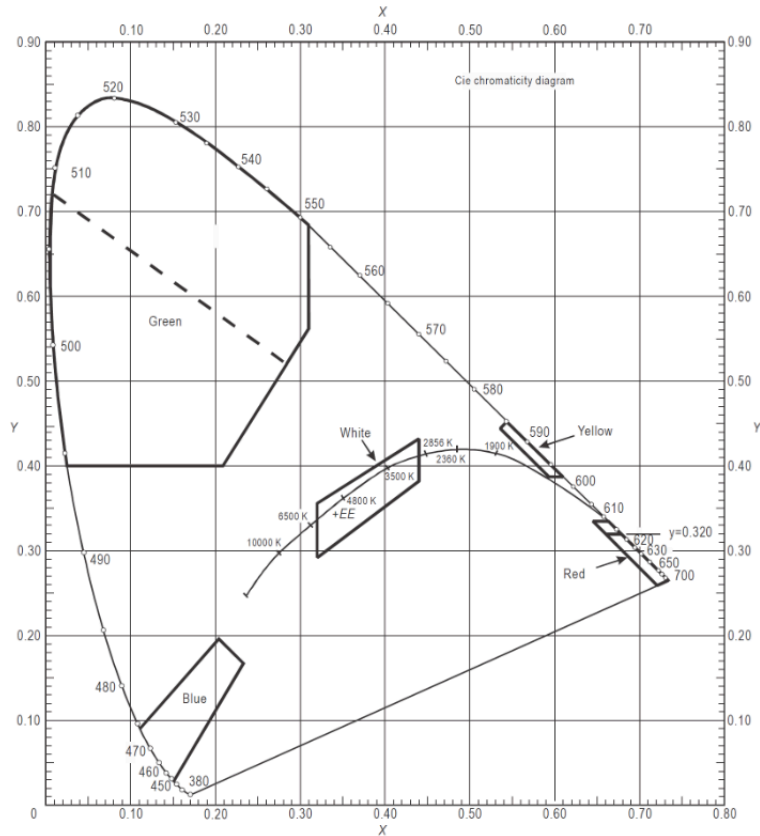

The measured trichromatic coordinates correspond to color range requirements in:

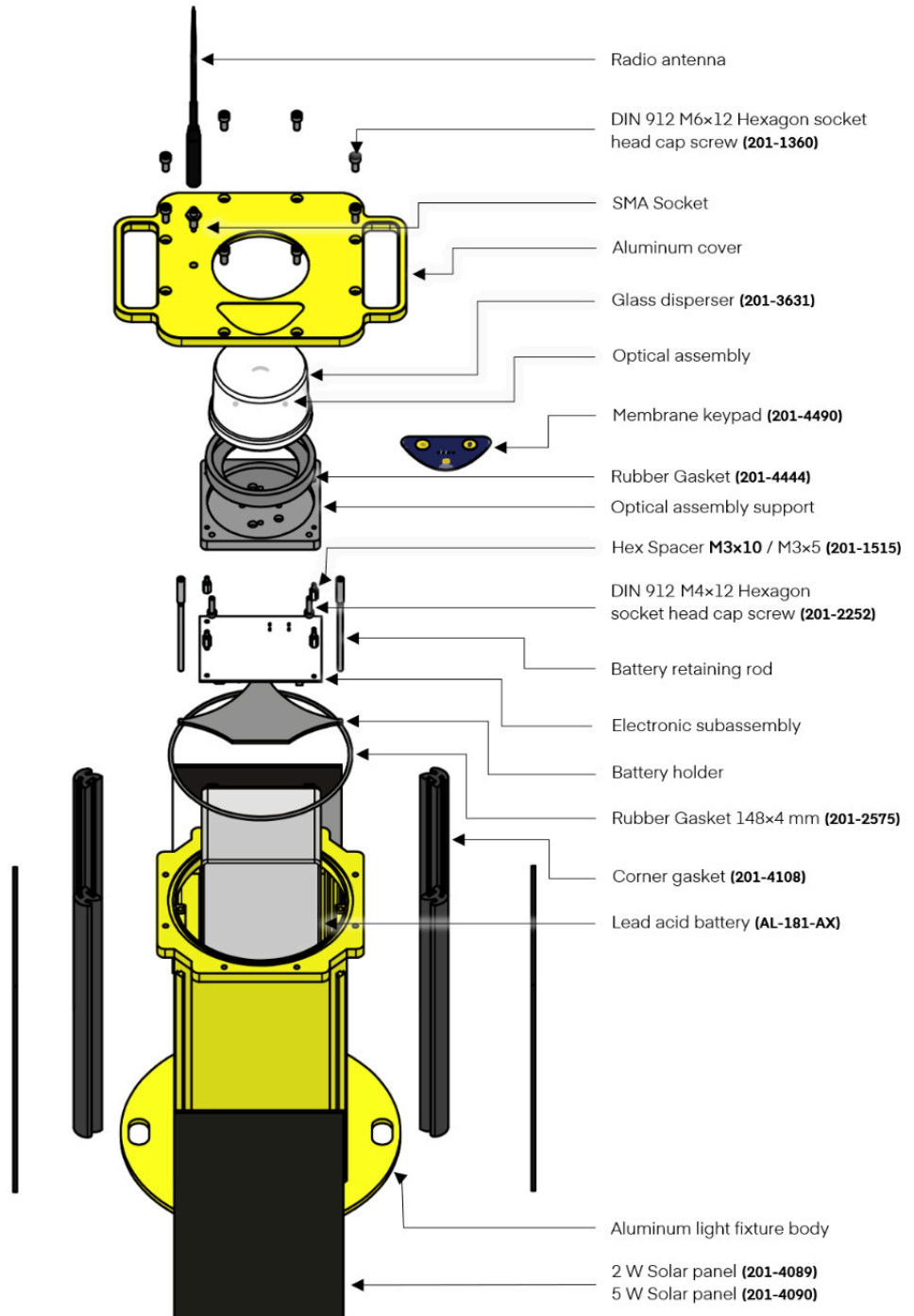

**ICAO Annex 14 - Aerodromes Vol.1, fig, A1-1b.
Colors for aeronautical ground lights (solid state lighting)**

Spare Parts

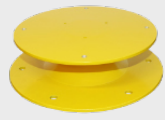

Accessory

To order accessories please call our customer support. For contact details please refer to our website - www.signalight.com

#	NAME - SERIES	PRODUCT CODE	IMAGE
1	Fixing System for Polaris V3	AL-232-AX	
2	Ground mounting screw	AL-229-AX	



Signalight

+40 254 515 465
office@signalight.com

36 Lunca Street, Petrosani,
Hunedoara County, Romania

www.signalight.com