



POLARIS RUNWAY END



<p>Description</p>	<p>Housing - powder coated aluminium RAL 1004 (aviation yellow) </p> <p>Dispenser - clear polycarbonate UV resistant</p> <p>Cable gland - nickel plated brass</p> <p>Fasteners - stainless steel</p> <p>Casing - polycarbonate UV resistant</p> <p>Carrying handle - aluminum</p> <p>Light fixtures are provided with anti condensation valve.</p>
<p>Environment</p>	<p>Temperature range: - 55° to +55°</p> <p>Degree of protection: IP X8</p> <p>Ka tested: Salt mist</p>
<p>Mounting</p>	<p>1. Polaris Solar panel stand AL-123-AX</p>  <p>2. Polaris base plate AL-124-AX</p> 

Electrical Characteristics

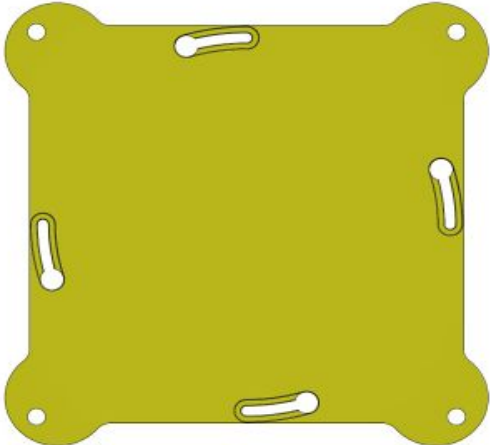
Power consumption: 5W

Power supply: Power supply is provided by 1 rechargeable deep cycle sealed lead acid battery 12V - 12Ah (optional different battery can be used)

Lifespan: 1200 cycles

User-replaceable

Air transportable

Battery Charging

The battery charger can be made in individual trays, in bigger racks or with solar panels.



Battery Monitoring & Charging:

The battery status is constantly monitored and a set of four LEDs gives a permanent indication.

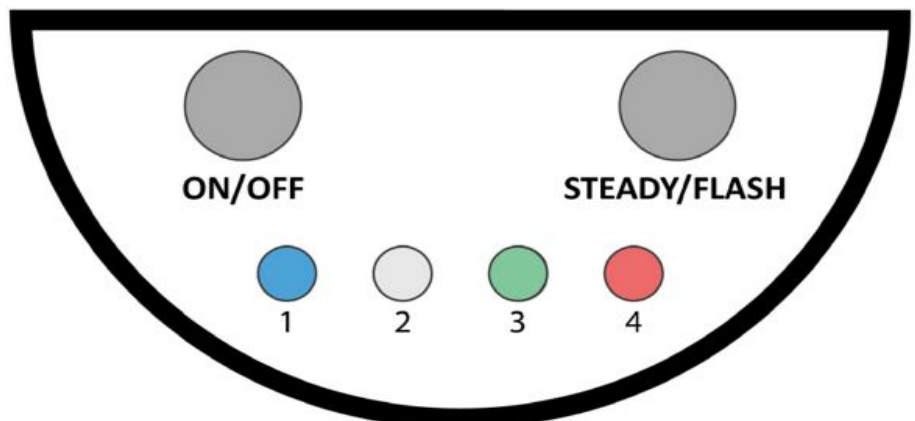

Mechanical
Characteristics

Width: 236.5 mm

Total height: 245 mm

Weight: 5.9 kg

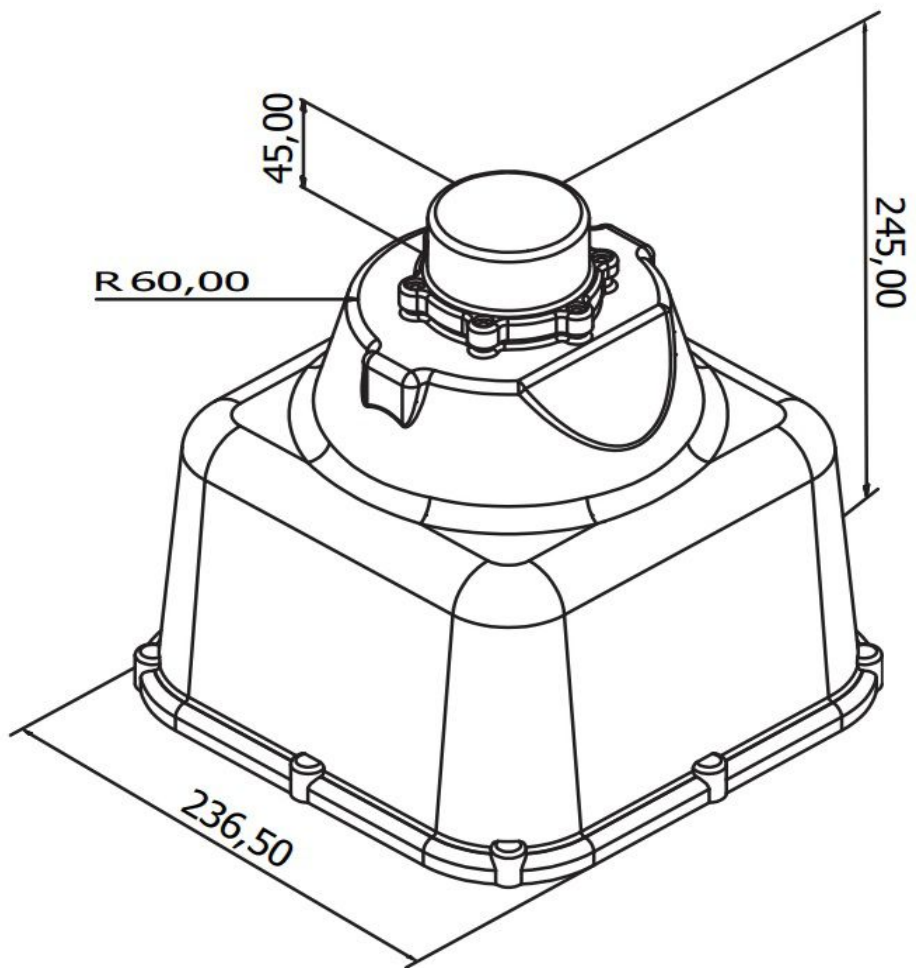

Photometric Characteristics

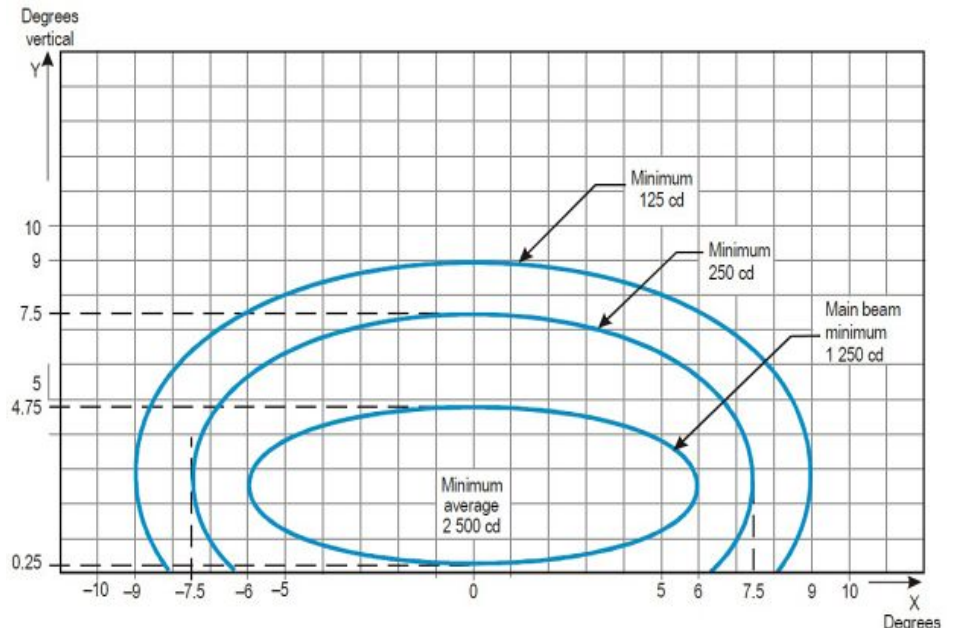

ICAO requirements Annex 14 Vol.1 Fig. A2-8.

Low intensity: 10% Average 250 cd

Medium intensity: 30% Average 750 cd

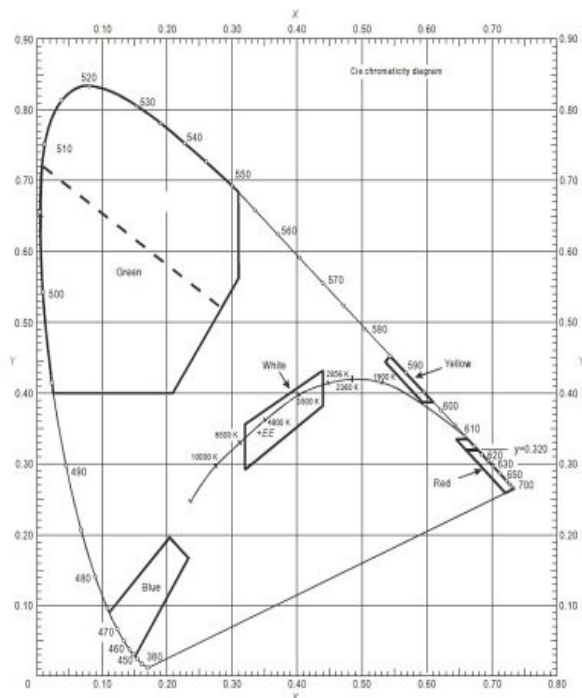





The measured trichromatic coordinates correspond to colour range requirements in:

**ICAO Annex 14 - Aerodromes Vol.1, fig, A1-1-1b.
Colours for aeronautical ground lights (solid state lighting)**

Accessory

To order accessories please call our customer support.
 For contact details please refer to our website - www.signalight.com

1	Polaris Solar panel stand	AL-123-AX	
2	Polaris base plate	AL-124-AX	
3	Individual charger	AL-125-AX	
4	Charging rack	AL-126-AX	



Signalight

+40 254 515 465
office@signalight.com

36 Lunca Street, Petrosani,
Hunedoara County, Romania

www.signalight.com